



Locking Cylinders with Individual Locking Function

Requirements and test methods

Publisher: VdS Schadenverhütung GmbH
Publishing house: VdS Schadenverhütung GmbH

Amsterdamer Str. 172-174
50735 Köln, Germany
Phone: +49 221 77 66 0; Fax: + 49 221 77 66 341

Copyright by VdS Schadenverhütung GmbH. All rights reserved.

VdS-Guidelines for Physical Security Devices

Locking Cylinders with Individual Locking Function

Requirements and test methods

These product guidelines are binding only if their application has been agreed between VdS and the applicant on an individual basis. Otherwise, an application of these product guidelines is non-binding; an agreement on the application of these product guidelines is purely optional. In individual cases, third parties may also accept other safety precautions or installation or maintenance companies under conditions that are defined at their sole discretion and that do not comply with these technical specifications.

Content

1	General	5
1.1	Scope.....	5
1.2	Validity	5
2	Normative References	5
3	Terms and Definitions	6
4	Classification	7
5	Requirements	7
5.1	General Requirements.....	7
5.2	Locking Cylinders for Use in Door Locks.....	7
5.2.1	Mounting Instructions.....	7
5.2.2	Effective Varieties	8
5.2.3	Keys	8
5.2.4	Declaration of the Manufacturer	8
5.2.5	Marking	9
5.2.6	Dimensions	9
5.2.7	Protection Against Picking Methods	9
5.2.8	Durability	10
5.2.9	Resistance against attacks with metal-cutting tools	10
5.2.10	Resistance against attacks with pulling tools	10
5.2.11	VdS-End-User Marking	10
5.3	Locking Cylinders for Ancillary Control Equipment of Intruder Alarm Systems..	11
5.3.1	General Requirements.....	11
5.3.2	Resistance Against Picking Attacks.....	11
5.3.3	Protection Against Corrosion	12
5.3.4	Registration of Delivered Keys	12

6	Test Methods	12
6.1	Conditions	12
6.1.1	Test Samples	12
6.1.2	Tolerances	12
6.2	Test Matrix	12
6.3	Initial Tests.....	13
6.3.1	Completeness	13
6.3.2	Identity	14
6.4	General Tests	14
6.4.1	Mounting Instructions.....	14
6.4.2	Declaration of the Manufacturer	14
6.4.3	Marking	14
6.4.4	Dimensions	14
6.4.5	Resistance Against Picking Attacks.....	14
6.4.6	Durability	15
6.4.7	Resistance Against Attacks with Metal-Cutting Tools	15
6.4.8	Resistance Against Attacks with Pulling Tools	15
6.5	Locking Cylinders for Ancillary Control Equipment of Intruder Alarm Systems..	16
6.5.1	Resistance Against Picking Attacks.....	16
6.5.2	Protection Against Corrosion (SO ₂)	16
6.5.3	Registration of Delivered Keys	16
6.6	Additional Tests	16
7	Changes	16
Anhang A	Declaration of the Manufacturer (normative)	17

1 General

1.1 Scope

These guidelines contain minimum requirements for locking cylinders with individual locking function and locking cylinders used in ancillary control equipment of intruder alarm systems as well as relating test methods. The guidelines are valid in connection with the German standards DIN 18252 and DIN EN 1303.

Deviating from DIN 18252, these guidelines can also be used in connection with other models (e.g. round or oval cylinders), as far as requirements and test methods can be applied logically.

The guidelines are not valid for locking cylinders and master key systems or for electronic locking systems. The requirements and test methods for these are shown in:

- VdS 2156-2 Locking Cylinders with Individual Locking Function, Electronic Locking Cylinders
- VdS 2215 Guidelines for Locking Systems
- VdS 2386 Guidelines for Master Key Systems

1.2 Validity

These guidelines are valid starting from 01.01.2016 and replace version VdS 2156 : 2012-07 (08).

Note: This is a translation of the German guidelines; if there are any discrepancies, the German version shall be binding.

2 Normative References

These guidelines contain dated and undated references to other publications. The normative references are cited at the appropriate places in the clauses, the publications are listed hereafter. For dated references, subsequent amendments to or revisions of any of these publications apply to these guidelines only when announced by a change of these guidelines. For undated references the latest edition of the publication referred will be applied.

- **DIN 18252 : 2006-12** Schließzylinder für Türschlösser: Begriffe, Maße, Anforderungen, Kennzeichnung (Locking cylinders for door locks, terms and conditions, measurements, requirements and labeling)
- **DIN EN 1303 : 2015-08** Schlösser und Baubeschläge, Schließzylinder für Schlösser; Anforderungen und Prüfverfahren (Locks and hardware, locking cylinders for locks, requirements and test methods)
- **VdS 2110** Richtlinien für Einbruchmeldeanlagen; Schutz gegen Umwelteinflüsse; Anforderungen und Prüfmethoden (Guidelines for intruder alarm systems, protection against environmental influences, requirements and test methods)
- **VdS 2119** Richtlinien für Einbruchmeldeanlagen; Schalteinrichtungen, Anforderungen (Guidelines for intruder alarm systems; ancillary control equipment (ACE), requirements)
- **VdS 2156-2** Schließzylinder mit Einzelsperrschließung, Anforderungen und Prüfmethoden, Teil 2, Elektronische Schließzylinder (Guidelines for physical security devices, locking cylinder with individual locking function, part 2: electronic locking cylinders)

- **VdS 2215** Richtlinien für Schließsysteme; Anforderungen und Prüfmethode (Guidelines for physical security devices, locking systems, requirements and test methods)
- **VdS 2344** Verfahren für die Prüfung und Anerkennung von Geräten, Bauteilen und Systemen der Brandschutz- und Sicherheitstechnik (Procedures for testing and the approval of equipment, components and systems used in fire protection and security technology)
- **VdS 2386** Richtlinien für Schließanlagen; Anforderungen und Prüfmethode (Guidelines for physical security devices, master key systems, requirements and test methods)

3 Terms and Definitions

For general terms and definitions refer to DIN 18252 and DIN EN 1303, clause 3. In addition the following definitions apply:

Attack side: The side of any façade element (e.g. door, window), which needs to be protected against an attack of any trespasser (e.g. the outside front of an apartment door).

Individual locking function: The individual locking of a cylinder, which is not a part of a master key system.

Copy of key: Key which is provided independently of the locking cylinder by the manufacturer or a third party on base of the known code or a presented key sample.

Original key: Key which is provided together with the locking cylinder by the manufacturer.

Ancillary control equipment (ACE): Operating device for setting/unsetting of IAS (e.g. ACE with physical identification feature).

Ancillary control equipment with physical identification feature: ACE with which setting/unsetting of an IAS is made by identification of physical features (e.g. keys, chip cards).

Special profile: Profile of a key which is protected against unauthorised copying of keys (e.g. patent protection, trademark protection).

Special key: Key, which disposes of a special profile with active protection or which is protected by technical copying protection against unauthorised manufacture of key copies.

Technical copying protection: Unauthorised manufacture of copied keys is rendered more difficult by special function elements or constructional features (e.g. by magnets, balls, sliders).

Pulling protection: In the sense of these guidelines any protection part or system at the cylinder, which prevents extracting the cylinder of the lock or the inside cylinder core of the cylinder body.

Note: Pulling protection may be realised also by the use of a burglar-resistant door blade.

Depending and double active detainers: Blocking elements that only open if getting confirmed and sorted accurately. If they are sorted too high or too low the cylinder keeps in blocked position.

4 Classification

Deviating from DIN 18252 resp. DIN EN 1303 locking cylinders in accordance to their performances are graded into the following classes:

- **Class A**
basic burglary protection
- **Class AZ**
basic burglary protection with pulling protection

All locking cylinders with **classification A** fulfill in addition to the higher requirements of these guidelines the requirements of DIN 18252, class 21, 31 or 71.

- **Class B**
medium burglary protection
- **Class BZ**
medium burglary protection with pulling protection
- **Class B+**
medium burglary protection with a very high resistance against attacks with unbarring tools. These cylinders are suited for use in ACE of intruder alarm systems.
- **Class BZ+**
medium burglary protection with pulling protection and with a very high resistance against attacks with picking tools. These cylinders are suited for use in ACE of intruder alarm systems.

All locking cylinders with **classification B** fulfill in addition to the higher requirements of these guidelines the requirements of DIN 18252, class 42 or 82.

Note: A higher burglar protection cannot be realised with mechanical cylinders only (exception: high resistance against attacks with unbarring tools). For this purpose cylinders have to fulfil the requirements of class C. This may be achieved by combining mechanical and electronic blocking techniques and/or biometric devices (cf. VdS 2156-2).

5 Requirements

5.1 General Requirements

The requirements of DIN 18252 and DIN EN 1303 are valid with the following deviations and/or additions.

5.2 Locking Cylinders for Use in Door Locks

5.2.1 Mounting Instructions

In addition to DIN 18252 every locking cylinder shall be provided with pictorial installation and operating manuals, written in German language.

Note: If the products are sold in non-German speaking area only, it is sufficient to attach the instructions in English language.

The mounting instructions shall contain a clear and detailed description of the installation process as well as all security measures and conditions of use (e.g. indication of attack side if only one side of the cylinder is provided with a protection against drilling).

The manual especially shall give a hint, that the cylinder is to be protected with a burglar resistant door plate (with or without pulling protection) of the respective class as well as a reference that the cylinder shall overlap the door plate not more than 3 mm.

5.2.2 Effective Varieties

Deviating from DIN EN 1303, clause 4.8.1 only those moving pins/levers are considered for calculation of the absolute number of differences of the code, that depend on each other and are double active.

In addition to DIN EN 1303, clause 4.8.1 and table 2 the locking codes may repeat in production for cylinders with individual locking function after 30,000 (**class A, AZ**) resp. 100,000 (**class B, BZ, B+, BZ+**) at the earliest.

5.2.3 Keys

In addition to DIN 18252 for cylinders with individual locking function, key profiles or patterns of drillings which are used in master key systems shall not be used.

Keys shall consist of nickel silver or material of higher quality regarding the stableness and corrosion features and shall dispose of a special profile.

Keys for locking cylinders of **class A and AZ** shall have a special profile with protection or shall be protected by a technical copying protections against unauthorised copying of keys (special keys).

Keys for **classes B, BZ, B+ and BZ+** locking cylinders shall have additional constructional features (e.g. protected key profile), that increase the difficulty of getting copies of keys.

The copying of keys and/or locking cylinders for **classes B and BZ** shall be restricted to the manufacturer or to dealers only which are authorised by the manufacturer, considering the following circumstances:

- The dealer shall be obliged to produce a copy of the key only if a security card is being presented.
- **Every** blank key that a dealer receives from the manufacturer has to be marked, so the dealer can be identified at any time.

If the dealer's proceeding with the blank keys does not fulfil the requirements mentioned, he shall no longer be supplied with blank keys by the manufacturer.

Keys for profile cylinder for **classes B+ and BZ+**, intended for the use in ancillary control equipment (ACE) of intruder alarm systems (IAS), shall only be produced by the manufacturer himself and delivered only against an authorisation identification. The manufacturer shall document all deliveries of these blank keys.

The validity period of the protection of the key profile has to be in line with the validity period of the VdS certificate at least.

5.2.4 Declaration of the Manufacturer

Additionally to the technical documentation required in DIN 18252, clause 8.3 a declaration of the manufacturer is to be submitted as shown in Annex A that the requirements concerning quantity and design of the code, the replication of the codes and the requirements for the keys according to clause 5.2.3 are considered.

5.2.5 Marking

Deviating from DIN 18252, clause 11 every locking cylinder shall be labeled permanently with the name/mark of the manufacturer or the holder of the approval and the type designation and the class. The type designation shall be identical with that in the technical documents and the advertising material and shall only be used for the approved locking cylinders.

In case of a one-sided protection against mechanical attacks the attack side shall be marked permanently.

In the mounted state of the locking cylinder no references to the code or drilling protection shall be visible.

In the mounted state of the profile cylinder, a visible marking of the cylinder or a marking of the key concerning the VdS approval is permitted.

A marking at the locking cylinder or at the key referring to the locking variation has to be coded. Without knowing the code it shall not be possible to determine the locking variation.

Note: All VdS markings shall be in accordance with the requirements of VdS 2344.

5.2.6 Dimensions

Deviating from DIN 18252, clause 4 pins, trips/cams or other devices may be attached on or at the cylinder body in a way, that they support themselves at the door shield in case of a pulling attack.

5.2.7 Protection Against Picking Methods

Locking cylinders in **classes A, AZ** shall have a simple and in **classes B, BZ** an increased protection against picking methods. A simple protection in **classes A, AZ** may be given if the following features are available:

- Profile cylinder without dimples fulfill the requirements of DIN 18252, clauses 7.1.1 to 7.1.7
- A minimum of two different body pin lengths are used and the difference of the length shall be two steps at the least
- For locking cylinders for keys with dimples, a minimum of two core pins shall be set in the front part (first 2/3) of the locking cylinders, which are long enough to be pushed into the housing in case of a picking attack at the pins behind them.

The cylinder shall not be overcome in case of a picking attack within 10 minutes.

An increased protection in **classes B, BZ** may be given if the following features are available:

- All features of classes A, AZ as before mentioned
- For locking cylinders driven with keys with cuts the keyway as well as the key profile shall be designed such that both profile lines overlap or touch the mid-line of the profile three times at the least and twice of that within the pin reading area of the core pins.

Additional blocking features are permitted, if the forced opening (picking) of the cylinder such way becomes effectively more difficult.

The cylinder shall not be overcome in case of a picking attack within 30 minutes.

5.2.8 Durability

In addition to DIN EN 1303, clause 4.3 locking cylinders equipped with a cam to operate the lock shall resist the force acting upon the cam during the locking procedure. Therefore deviating from DIN EN 1303, clause 6.3 a test according to clause 6.4.6 and table 5-1 of these guidelines shall be performed.

Class	Number of locking cycles
A, AZ	100.000
B, BZ, B+, BZ+	200.000

Table 5-1 Durability

5.2.9 Resistance Against Attacks with Metal-Cutting Tools

Deviating from DIN EN 1303, clause 4.9.2 locking cylinders tested according to clause 6.4.7 of these guidelines shall resist a minimum time as shown in table 5-2 in case of attacks with metal-cutting tools.

Class	Minimum resistance time	Total test time
A, AZ	3 min	10 min
B, BZ, B+, BZ+	6 min	15 min

Table 5-2 Resistance to attacks with metal-cutting tools

5.2.10 Resistance Against Attacks with Pulling Tools

Deviating from DIN EN 1303, clause 4.9.5 locking cylinders tested according to clause 6.4.8 of these guidelines shall resist a minimum time as shown in table 5-3 in case of attacks with pulling tools.













Class	max. extraction force	Minimum resistance time
AZ	15 kN	3 min
BZ, BZ+	15 kN	6 min

Table 5-3 Resistance to attacks with extraction tools

For **class A, B** and **B+** cylinder it is required that the technical documentation of the manufacturer contains the information that the locking cylinder shall be used only in connection with a VdS approved burglar-resistant door shield of the corresponding class with pulling protection.

5.2.11 VdS-End-User Marking

Sales packagings of VdS-approved locking cylinders shall be marked for a better understanding for the end-user with the markings according to table 5-4. These markings should also be affixed to the products themselves.

Class	Markings of packagings ²⁾	Markings of products ²⁾
A	  with remark ¹⁾	
AZ	 	
B	  with remark ¹⁾	
BZ	 	
<p>¹⁾ The logos may be obtained from VdS by the approval owner (as file in pixel or vector graphics). For the use of VdS-end-user marking the requirements of VdS 2344 for the use of the VdS logo are valid in analogy.</p> <p>²⁾ For locking cylinders of class A and B, besides the end-user marking, it shall be clearly pointed out that the locking cylinder is to be used in combination with VdS-approved burglar resistant door plates only. The following phrases are recommended for this purpose: „Protection plate with cylinder cover necessary“</p>		
Table 5-4: End-user marking		

5.3 Locking Cylinders for Ancillary Control Equipment of Intruder Alarm Systems

5.3.1 General Requirements

Locking cylinders of class **B** and **BZ+** that are intended for the use in ancillary control equipment (ACE) of intruder alarm systems (IAS) (cf. Guidelines for Ancillary Control Equipment, VdS 2119) shall fulfill the requirements of class B as well as the following requirements.

5.3.2 Resistance Against Picking Attacks

The locking cylinder shall have a very high resistance against picking attacks. This can be given if one of the following features is existing:

- The pins/levers of the blocking system are arranged in multiple ranks.
- Beside the normal blocking system more depending and double active retainers are existing.
- Blocking systems are given, which cannot be attacked with manipulation tools (e.g. magnetic detainer).

The cylinder shall not be overcome in case of an attack with opening tools within 90 minutes.

5.3.3 Protection Against Corrosion

Analogue to the guidelines VdS 2119, locking cylinders for ancillary control equipment shall have a sufficient resistance against corrosion, corresponding to the test described in clause 6.5.2.

5.3.4 Registration of Delivered Keys

The manufacturer shall operate a documentation system for the delivery of keys for locking cylinders for ACE of IAS.

6 Test Methods

6.1 Conditions

6.1.1 Test Samples

For the technical test in a laboratory 10 test samples taken of the series production with the corresponding keys and the required construction documentation denoted in DIN 18252, clause 8.3 shall be provided by the manufacturer.

To test the security against next closest keys the manufacturer has to provide two extra keys that are deviating from the corresponding key with a cut one step higher and a cut one step lower.

If the product is not yet in series production the test can be done on prototypes. In this case a verification with products coming out of the series production is necessary to get the final result.

The different sales packagings which are marked with the VdS end-user marking according to clause 5.2.11 are also to be provided by the manufacturer.

6.1.2 Tolerances

If not specified otherwise, the tolerance for strength and torque information is $\pm 5\%$.

6.2 Test Matrix

The individual tests are carried out according to the sequence as in the following test matrix. If one sample fails during the test it shall be decided on an individual basis, according to consultation with the manufacturer where appropriate, whether and with which step the test program will be continued.

Test no	Test	DIN EN 1303 Clause	DIN 18252 clause	VdS 2156-1 clause	Test sample										
					1	2	3	4	5	6	7	8	9	10	
1	Completeness			6.3.1	x	x	x	x	x	x	x	x	x	x	x
2	Identity			6.3.2	x	x	x	x	x	x	x	x	x	x	x
3	Mounting instructions			6.4.1	x	x	x	x	x	x	x	x	x	x	x
4	Declaration of manufacturer			6.4.2	x	x	x	x	x	x	x	x	x	x	x
5	Registration of delivered keys			6.5.3	x	x	x	x	x	x	x	x	x	x	x
6	Marking	8	11	6.4.3	x	x	x	x	x	x	x	x	x	x	x
7	Dimensions		8.4	6.4.4	x	x	x								
8	Construction	6.8.1–6.8.4	8.5, 8.6		x	x	x								
9	Protection against unbarring			6.4.5 6.5.1	x	x	x								
10	Function at extreme temperatures	6.7.2			x	x	x								
11	Protection against copying	6.8.5			x	x	x								
12	Durability	6.3		6.4.6	x	x	x								
13	Stability of keys	6.2			x	x	x								
14	Stability against dimming	6.9.3			x	x	x								
15	Attack with chisel	6.9.2			x	x	x								
16	Protection against corrosion (salt spray test)	6.7.1						x	x	x					
17	Protection against corrosion (SO ₂)*			6.5.2				x	x	x					
18	Resistance against attack with metal-cutting tools	6.9.1		6.4.7				x	x	x					
19	Resistance against attack with pulling tools	6.9.4		6.4.8							x	x	x		
20	Resistance against torsion of the cylinder and/or the cylinder core	6.8.6									x	x	x		
21	Additional tests			6.6											x

* Tests only for locking cylinders for ACE of IAS

Table 6-1: Test matrix

6.3 Initial Tests

6.3.1 Completeness

It is tested whether the test samples including the corresponding keys as well as the required documents and accessories are available completely.

6.3.2 Identity

It is tested by means of visual check and measurements whether the test samples correspond to the information of the manufacturer. Only if no deviations are found at this the subsequent examinations are going to start.

6.4 General Tests

6.4.1 Mounting Instructions

It is tested whether a mounting instruction is attached to each locking cylinder according to the requirements (cf. clause 5.2.1) and if it contains the required notes.

6.4.2 Declaration of the Manufacturer

It is tested whether the declaration of the manufacturer was submitted according to the requirements (cf. clause 5.2.4).

6.4.3 Marking

It is tested whether every locking cylinder is marked with the required information (cf. clause 5.2.5) and if any references to the locking secret on the cylinder or the keys are coded.

Furthermore it is tested, whether each marking is sufficiently steady, e.g. by peeling, wiping with a moist cloth or by simple scraping.

All types of packagings bearing the enduser marking according to clause 5.2.11 are checked on correctness.

6.4.4 Dimensions

The dimensional inspection is carried out according to DIN 18252, clause 8.4 respectively clause 5.2.6 of these guidelines.

6.4.5 Resistance Against Picking Attacks

It is tested whether an adequate protection against picking attacks is given according to clause 5.2.7.

The opening security is determined by manual tests. The test performance has to be recorded.

6.4.6 Durability

The test is described in DIN EN 1303, clause 6.3. For locking cylinders with a cam, the cam shall be subjected to a force during the turn of the key in an angle range from 315° to 45° with a vertical force of 15 N (for example a weight of 1.5 kg; cf. figure 6-1).

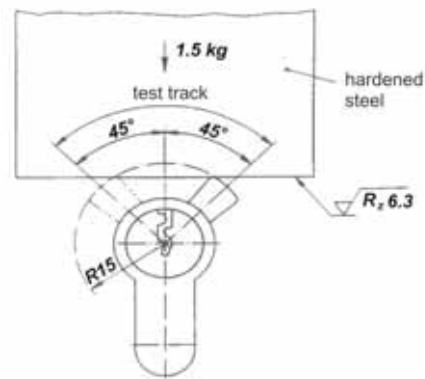

Figure 6-1: Conditioned angle range

6.4.7 Resistance Against Attacks with Metal-Cutting Tools

For testing of the resistance against mechanical attacks the sample will be mounted in a door replication made of steel including a mortise lock and a burglary-resistant door shield.

The attack starts on the front end of the profile cylinder with an electric drill with maximum 1000 W nominal capacity and adjustable speed up to 3000 rpm. The drilling will be done with carbide drills or high-speed steel drills of 2 mm to 7 mm diameter or HSS-drills of 2 mm to 12 mm diameter which can be edged especially for the intended purpose. The number of drills is not limited.

The electric drill can be equipped with a depth stop.

The points of attack will be specified by the tester on base of the construction documents and noted in the test protocol.

Exclusively the working time (net time) will be count. Exchanging of drill bits is counted as 10 s working time. The total test time consists of the resistance time and the time for e.g. cleaning of drilling hole, removal of swarfs or pins, locking attempts a.o. Times for test documentation (recording, photo shooting) are not counted to the total test time.

The profile cylinder fails if within the minimum resistance time according to the security class (cf. clause 5.2.9) the blocking elements were destroyed or manipulated in a way that the locking cylinder can be operated at least one time.

The test will be executed at 3 test samples. The worst result will be considered for the evaluation.

6.4.8 Resistance Against Attacks with Pulling Tools

For testing the pulling prevention the sample will be mounted in a door replication made of steel including a mortise lock and a burglary-resistant door shield.

Within the minimum resistance time for the relevant class (cf. clause 5.2.10) different screws will be turned into the cylinder (either directly or by use of drilling tools).

By means of a test rig the maximum possible pulling force will be determined.

The profile cylinder fails if at a force of ≤ 15 kN the core can be pulled out of the housing or the whole cylinder will be pulled out of the lock so that an operating of the lock can be done.

If it is not possible to turn in a screw within the minimum resistance time or the force of the turned screw cannot be transferred to the locking cylinder, the requirements are fulfilled.

6.5 Locking Cylinders for Ancillary Control Equipment of Intruder Alarm Systems

6.5.1 Resistance Against Picking Attacks

It is tested whether the features described in clause 5.3.1 will provide the adequate resistance against unbarring attempts.

The opening security will be determined by manual tests. The execution of the tests has to be recorded.

6.5.2 Protection Against Corrosion (SO₂)

A K3-test is performed according to VdS 2110 with 15 cycles and 0.2 l SO₂. Once after each test cycle the cylinder has to be operated.

After the test it shall be possible to operate the cylinder with a maximum torque of 2.5 Nm.

6.5.3 Registration of Delivered Keys

It is tested whether the manufacturer disposes of a documentation system for the delivery of keys for locking cylinders for ACE of IAS.

6.6 Additional Tests

New constructions or production methods as well as new opening tools or methods may require additional tests.

7 Changes

Compared with version VdS 2156 : 2012-07 (08) the following changes were made:

- Adaption to DIN EN 1303:2015-08
- Editorial changes

Anhang A Declaration of the Manufacturer (normative)

Declaration of the Manufacturer

With this we declare, that for manufacturing of the locking cylinder

model _____

in our factory _____

the following organizational measures were taken:

Code variations

A permutation table was created, according to which at random _____ code variations can be produced.

The requirements regarding DIN EN 1303, clause 4.8.4 and DIN 18252, clauses 7.1.1 to 7.1.7 are being considered.

It is guaranteed, that a code is repeated at the earliest after _____ produced variations.

Keys

For locking cylinders with coded individual locking functions only key profiles are being used, that are not in use for master key systems. For cylinders in classes B, B+, BZ and BZ+ only protected profiles are being used. Blank keys will be delivered through authorized dealers only.

The delivery of copies of keys or cylinders with the same code requires the presentation of an identification approval.

Every delivered key and locking cylinder for ancillary control equipment of intruder alarm systems are being registered by us.

The key profile protection is valid for the next _____ years to come.

_____, the _____

Stamp/signature